



# **RF / Microwave PC Board** **Design and Layout**

**Rick Hartley**  
**L-3 Avionics Systems**  
**richard.hartley@L-3com.com**

1



## **RF / Microwave Design - Contents**

- 1) Recommended Reading List
- 2) Basics
- 3) Line Types and Impedance
- 4) Integral Components
- 5) Layout Techniques / Strategies
- 6) Power Bus
- 7) Board Stack-Up
- 8) Skin Effect and Loss Tangent
- 9) Shields and Shielding
- 10) PCB Materials, Fabrication and Assembly

2



## **RF / Microwave - Reading List**

### **PCB Designers –**

- Transmission Line Design Handbook – Brian C. Wadell (Artech House Publishers) – ISBN 0-89006-436-9
- HF Filter Design and Computer Simulation – Randall W. Rhea (Noble Publishing Corp.) – ISBN 1-884932-25-8
- Partitioning for RF Design – Andy Kowalewski - Printed Circuit Design Magazine, April, 2000.
- RF & Microwave Design Techniques for PCBs – Lawrence M. Burns - Proceedings, PCB Design Conference West, 2000.

3



## **RF / Microwave - Reading List**

### **RF Design Engineers –**

- Microstrip Lines and Slotlines – Gupta, Garg, Bahl and Bhartia. Artech House Publishers (1996) – ISBN 0-89006-766-X
- RF Circuit Design – Chris Bowick. Newnes Publishing (1982) – ISBN 0-7506-9946-9
- Introduction to Radio Frequency Design – Wes Hayward. The American Radio Relay League Inc. (1994) – ISBN 0-87259-492-0
- Practical Microwaves – Thomas S. Laverghetta. Prentice Hall, Inc. (1996) – ISBN 0-13-186875-6

4



## **RF / Microwave Design - Basics**

- ◆ RF and Microwave Layout encompasses the Design of Analog Based Circuits in the range of Hundreds of Megahertz (MHz) to Many Gigahertz (GHz).
- ◆ RF actually in the 500 MHz - 2 GHz Band. (Design Above 100 MHz considered RF.)
- ◆ Microwave above 2 GHz.

5



## **RF / Microwave Design - Basics**

- ◆ Unlike Digital, Analog Signals can be at any Voltage and Current Level (Between their Min & Max), at any point in Time.
- ◆ Standard Analog Signals are assumed to be between DC and a few Hundred MHz.
- ◆ RF/Microwave Signals are One Frequency or a Band of Frequencies imposed on a Very High Frequency Carrier.

6



## **RF / Microwave Design - Basics**

- ◆ RF/Microwave Circuits are Designed to Pass Signals within Band of Interest and Filter Energy outside that Range.
- ◆ Signal Band can be Narrow or Wide.
  - ◇ Narrow Band Circuits usually have Pass Band less than 1 MHz.
  - ◇ Broad Band Circuits Pass a Range of Frequencies up to 10's of MHz.

7



## **RF / Microwave Design - Basics**

- ◆ When Digital and Microwave exist in the Same Unit, Pass Bands of Microwave Circuits usually fall (by design) Outside the Harmonic Range of the Digital Signals.

8



## **RF / Microwave Design - Basics**

- ◆ RF / Microwave PC Board Layout simply follows the “Laws of Physics”-
- ◆ When Laws of Physics can't be followed, Know what Compromises are available.

**THIS IS NOT BLACK MAGIC!!!**

9



## **RF / Microwave Design - Basics**

- ◆ Microwave Signals are Very Sensitive to Noise, Ringing and Reflections and Must be treated with Great Care.
- ◆ Need Complete Impedance ( $Z_0$ ) Matching (50 ohm out/ 50 ohm line/ 50 ohm in).
  - ◇ Minimizes Return Loss / VSWR.

10

## RF / Microwave Design - Basics

- ◆ A Transmission Line is any Pair or Wires or Conductors used to Move Energy From point A to point B, Usually of Controlled Size and in a Controlled Dielectric to create a Controlled Impedance ( $Z_0$ ).

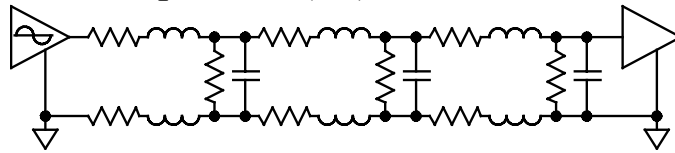

Evenly Distributed R, L, G & C –  $Z_0 = \sqrt{\frac{R}{G} + \frac{j\omega L}{j\omega C}}$

11

## RF / Microwave Design - Basics

- ◆ Inductance (L) is Determined by the Loop Function of Signal and Return Path.
  - ◇ Small Spacing (Tight Loop) creates High Flux Cancellation, hence Low Inductance.
- ◆ Capacitance (C) is Function of Signal spacing to the Return Path.
  - ◇ Small Spacing creates High Capacitance.

12



## RF / Microwave Design - Basics

- ◆ Since Small Spacing (Tight Loop) creates Low L & High C and since  $Z_0 = \sqrt{L/C}$ , Small Spacing creates Low  $Z_0$ .
- ◆ Additionally,  $Z_0$  is function of Signal Conductor Width & Thickness and a Function of the Dielectric Constant ( $\epsilon_r$ ) of the Material surrounding the Lines.

13



## RF / Microwave Design - Basics

- ◆ Sometimes Dielectric surrounding Transmission Line isn't Constant (Outer Layer Trace on PCB).
  - ◇ DK above Trace is Air (= 1.0008).
  - ◇ DK below Trace is FR4 (approx = 4.1).
  - ◇ Effective Relative  $\epsilon_r$  ( $\epsilon_{eff}$ ) is 3 to 3.25.
- ◆ Equations given later to Calculate Effective Relative  $\epsilon_r$  ( $\epsilon_{eff}$ ).

14

## RF / Microwave Design - Basics

- ◆ Signal Return Currents follow the Path of Least Impedance (In High Frequency Circuits that = Path of Least Inductance).
- ◆ Whenever we Neglect to provide a Low Impedance Return Path for RF / Microwave signals, they WILL find a Path.
- ◆ It may NOT be what we had in mind.

15

## RF / Microwave Design - Basics

- ◆ Signal Wavelength -
  - ◇ Wavelength ( $\lambda$ ) of a Signal is the Distance it Travels in the Time of One Cycle.
- ◆ For a Signal Traveling in Free Space -
  - ◇  $\lambda = c$  (Speed of Light) /  $f$  (frequency).  
( $\lambda = 11.78''/\text{nSec}$  at 1GHz = 11.78'')
- ◆ Signal in a Higher  $\epsilon_r$  Dielectric -
  - ◇  $\lambda = c / f \cdot 1 / \sqrt{\epsilon_r}$

16



## RF / Microwave Design - Basics

### ◆ Signal Critical Length-

- ◇ How long a PCB Trace can be before we MUST pay attention to Impedance Control.
- ◇ Function of Frequency (1/16th Wavelength)

$$L_{critical} = \frac{c}{f} \cdot \frac{1}{\sqrt{\epsilon_{eff}}} \cdot \frac{1}{16}$$

- ◆ At 1 GHz = approx .425" (Microstrip- FR4)
- ◆ At 1 GHz = approx .375" (Stripline - FR4) <sup>17</sup>

## RF / Microwave Design - Basics

### Signal Loss / Noise -

#### ◆ Reflections -

- ◇ Return Loss / VSWR

#### ◆ Skin Effect -

- ◇ Increased Resistance of PCB Trace due to Decreased Cross Sectional Area.
- ◇ In Analog Circuits above 100 MHz.
- ◇ Skin Depth- .000822" @ 10 MHz.  
.000026" @ 10 GHz.

## RF / Microwave Design Basics

### Signal Loss / Noise -

#### ◆ Loss Tangent -

- ◇ Dielectric Loss caused by Molecular Structure of Board Material.
- ◇ In Analog Circuits above 200 MHz.
- ◇ PTFE's Far Better than FR4.

#### ◆ Energy Coupling-

- ◇ Cross Talk.
- ◇ Noise Induction.

19

## RF / Microwave Design - Line Types and Impedance ( $Z_0$ )

#### ◆ Waveguide-

- ◇ Uses Air as Transmission Medium and Side Walls of Tube as Return Path.
- ◇ Won't Support Energy Propagation Below Cutoff Frequency.
- ◇ Works Best at Ultra High Frequencies with Millimeter Wavelengths.

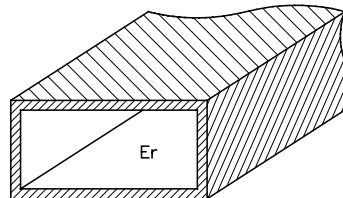

20



## **RF / Microwave Design -** **Line Types and Impedance (Zo)**

- ◆ Waveguide -
  - ◇ With an Air Dielectric, Signals Propagate at the Speed of Light.
  - ◇ Very Low Loss due to Smooth Side Walls and the Air Dielectric.
  - ◇ Ultra Low Loss with High Density, Ultra Smooth Coating on Walls.
  - ◇ In Very High Power applications, Uses Solid Dielectric to Prevent Voltage Arcing.

21



## **RF / Microwave Design -** **Line Types and Impedance (Zo)**

- ◆ Signal Traces Longer than Critical Length ( $1/16 \lambda$  in DK) Need Impedance Control to Prevent Return Loss due to Reflections.
- ◆ Shorter Circuit Elements Don't Require Impedance Control, but it Usually does NO Harm.
- ◆ Don't bother to Zo Control Short Lines if it Will create a Problem (ie- DFM).

22



## **RF / Microwave Design - Line Types and Impedance ( $Z_0$ )**

- ◆ Impedance (L/C)-
  - ◇ Lower  $\epsilon_r$  Materials Net Higher Impedance Traces and Faster Propagation Times per given Trace Width & Trace-to-Ground Separation.
  - ◇ As Trace Width Increases, Trace Impedance Decreases (Thickness has Min Effect).
  - ◇ As Trace Spacing from Ground Increases, Impedance Increases.

23



## **RF / Microwave Design - Line Types and Impedance ( $Z_0$ )**

### Transmission Line History -

- ◆ Two Coplanar Strips in 1936. Later Rolled Up to create Sealed Line.
- ◆ Coax Lines during WWII.
- ◆ Flat Stripline Using PCB Techniques right after WWII.
- ◆ First use of Microstrip Reported in 1949.

24

## RF / Microwave Design - Line Types and Impedance (Zo)

### Microstrip

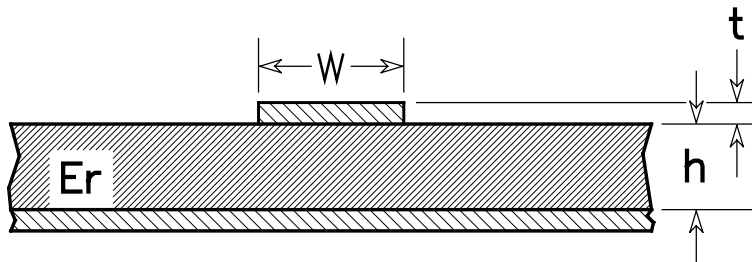

25

## RF / Microwave Design - Line Types and Impedance (Zo)

### Microstrip

$$Z_0 = \frac{120\pi}{2.0\sqrt{2.0\pi}\sqrt{\epsilon_r+1.0}} \ln \left\{ 1.0 + \frac{4.0h}{w'} \left[ \frac{14.0+8.0/\epsilon_r}{11.0} \frac{4.0h}{w'} \right. \right. \\ \left. \left. + \sqrt{\left( \frac{14.0+8.0/\epsilon_r}{11.0} \right)^2 \left( \frac{4.0h}{w'} \right)^2 + \frac{1.0+1.0/\epsilon_r}{2.0} \pi^2} \right] \right\} (\Omega)$$

where:  $w' = w + \Delta w'$

$$\Delta w' = \Delta w \left( \frac{1.0+1.0/\epsilon_r}{2.0} \right)$$

**(Replace Er**  
**with Eeff)**

$$\frac{\Delta w}{t} = \frac{1.0}{\pi} \ln \left[ \frac{4e}{(t/h)^2 + \left( \frac{1/\pi}{w/t+1.1} \right)^2} \right]$$

26

## RF / Microwave Design - Line Types and Impedance (Z<sub>0</sub>)

### Microstrip

$$Z_0 = \frac{60}{\sqrt{\epsilon_{eff}}} \cdot \ln\left(\frac{8h}{w} + \frac{w}{4h}\right) \quad \text{if } \frac{w}{h} < 1$$

otherwise

$$Z_0 = \frac{120\pi}{\sqrt{\epsilon_{eff}}} \cdot \frac{1}{\left(\frac{w}{h} + 1.393 + 0.677 \cdot \ln\left(\frac{w}{h} + 1.444\right)\right)}$$

27

## RF / Microwave Design - Line Types and Impedance (Z<sub>0</sub>)

### Microstrip

$$\epsilon_{eff} = \frac{\epsilon_r + 1}{2} + \frac{\epsilon_r - 1}{2} \left[ \frac{1}{\sqrt{1 + \frac{12h}{w}}} + 0.04 \left(1 - \frac{w}{h}\right)^2 \right] \quad \text{if } \frac{w}{h} < 1$$

otherwise

$$\epsilon_{eff} = \left[ \frac{\epsilon_r + 1}{2} + \frac{\epsilon_r - 1}{2} \left[ \frac{1}{\sqrt{1 + \frac{12h}{w}}} \right] \right]$$

28

## RF / Microwave Design - Line Types and Impedance (Zo)

### Embedded Microstrip

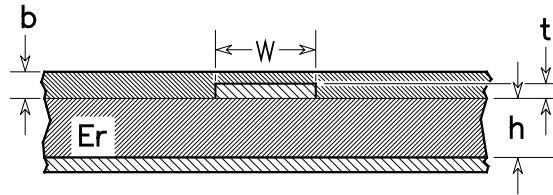

Multiply Zo (from Microstrip) by -

$$\frac{\epsilon_{eff}}{\epsilon_{eff} \cdot e^{(-2.0b/h)} + \epsilon_r [1.0 - e^{(-2.0b/h)}]}$$

Can use w/Soldermask over Microstrip (Often NOT Needed) <sup>29</sup>

## RF / Microwave Design - Line Types and Impedance (Zo)

### Centered Stripline

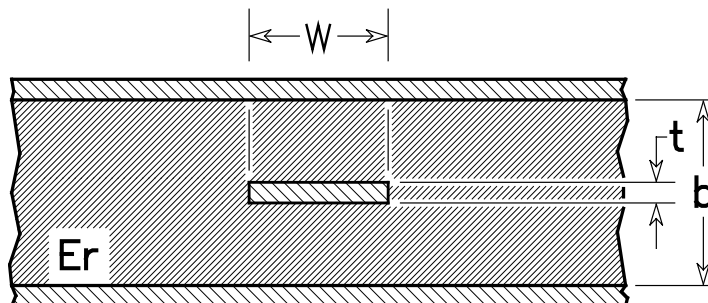

## RF / Microwave Design - Line Types and Impedance (Zo)

### Centered Stripline

$$Z_0 = \frac{120\pi}{2.0\pi\sqrt{\epsilon_r}} \ln \left\{ 1.0 + \frac{4.0(b-t)}{\pi w'} \left[ \frac{8.0(b-t)}{\pi w'} + \sqrt{\left( \frac{8.0(b-t)}{\pi w'} \right)^2 + 6.27} \right] \right\}$$

where:  $b = 2.0h + t$

$$w' = w + \frac{\Delta w}{t}$$

$$\frac{\Delta w}{t} = \frac{1.0}{\pi} \ln \left[ \frac{e}{\sqrt{\left( \frac{1}{2.0(b-t)/t+1} \right)^2 + \left( \frac{.25\pi}{w/t+1.1} \right)^m}} \right]$$

31

## RF / Microwave Design - Line Types and Impedance (Zo)

### Off-Center Stripline

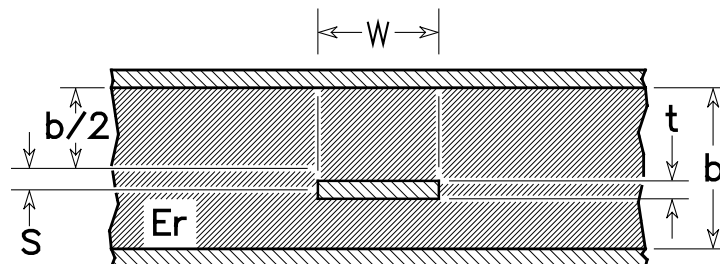

(Equations in Wadell- Pages 130-133)

32



## RF / Microwave Design - Line Types and Impedance ( $Z_0$ )

### Microstrip versus Stripline

- ◆ Microstrip has Lower Loss Tan Problem.
- ◆ Microstrip has Faster Propagation Time.
- ◆ Stripline has Better Immunity to Crosstalk.
- ◆ Stripline has Better EMI Characteristics.

33

## RF / Microwave Design - Line Types and Impedance ( $Z_0$ )

### Coplanar Waveguide

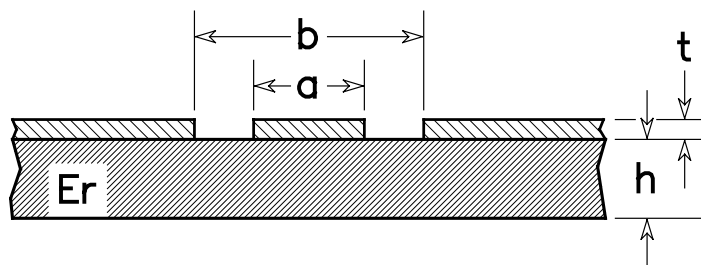

- ◆ 'b' should be less than  $\lambda/2$  for best performance.
- ◆ Ground Must extend Greater than  $5 \times 'b'$  on either side of Trace 'a'.

34



## **RF / Microwave Design - Line Types and Impedance ( $Z_0$ )**

### **Coplanar Waveguide**

- ◆ Lower Loss Tangent than Microstrip (Signals Couple Mostly through Air).
- ◆ Higher Skin Effect Losses (Fields Concentrate on Edges of Trace and Grounds).
- ◆ May Need to Strap Grounds together on Either Side of Trace, every  $1/20$ th Wavelength.
- ◆ Only Need One Side of Board to be Accessible.
- ◆ No Plated Holes Needed,
- ◆ Can Narrow Trace to Match Component Leads.

35



## **RF / Microwave Design - Line Types and Impedance ( $Z_0$ )**

### **Coplanar Waveguide**

- ◆ CPW Allows Variation of Trace Width, or Spacing-to-Ground or Dielectric Thickness to Control  $Z_0$ .
- ◆  $Z_0$  of CPW Decreases as Dielectric Thickness Increases.
- ◆ CPW Produces Smaller Trace per given  $Z_0$  than Microstrip.

36

## RF / Microwave Design - Line Types and Impedance (Zo)

### Coplanar Waveguide

$$Z_0 = \frac{30.0\pi}{\sqrt{\epsilon_{eff,t}}} \cdot \frac{K(kt')}{K(kt)}$$

$$k1 = \frac{\sinh\left(\frac{\pi a_t}{4.0h}\right)}{\sinh\left(\frac{\pi b_t}{4.0h}\right)}$$

$$\epsilon_{eff,t} = \epsilon_{eff} - \frac{\epsilon_{eff} - 1.0}{\frac{(b-a)/2.0}{0.7t} \cdot \frac{K(k)}{K'(k)} + 1.0}$$

$$k1' = \sqrt{1.0 - k1^2}$$

$$\epsilon_{eff} = 1.0 + \frac{\epsilon_r - 1.0}{2.0} \cdot \frac{K(k')K(k1)}{K(k)K(k1')}$$

$$a_t = a + \frac{1.25t}{\pi} \left[ 1.0 + \ln\left(\frac{4.0\pi a}{t}\right) \right]$$

$$k_t = \frac{a_t}{b_t} \quad k = \frac{a}{b}$$

$$b_t = b - \frac{1.25t}{\pi} \left[ 1.0 + \ln\left(\frac{4.0\pi a}{t}\right) \right]$$

$$k_t' = \sqrt{1.0 - k_t^2} \quad k' = \sqrt{1.0 - k^2}$$

37

## RF / Microwave Design - Line Types and Impedance (Zo)

### CPW versus Microstrip

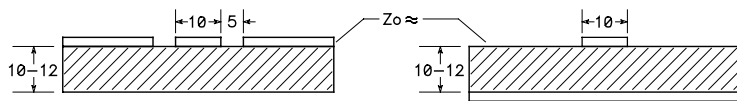

$$\epsilon_r = 4.2 - Z_0 = 76 \quad (\epsilon_{eff} = 2.44 \text{ (CPW) \& } 3.02 \text{ (MS)})$$

$$\epsilon_r = 2.5 - Z_0 = 94 \quad (\epsilon_{eff} = 1.66 \text{ (CPW) \& } 1.96 \text{ (MS)})$$

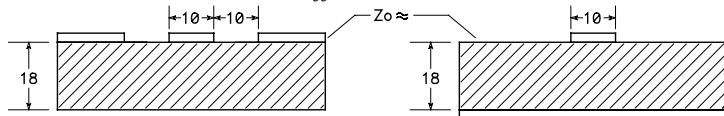

$$\epsilon_r = 4.2 - Z_0 = 94 \quad (\epsilon_{eff} = 2.45 \text{ (CPW) \& } 2.95 \text{ (MS)})$$

$$\epsilon_r = 2.5 - Z_0 = 115 \quad (\epsilon_{eff} = 1.68 \text{ (CPW) \& } 1.92 \text{ (MS)})$$

38

## RF / Microwave Design - Line Types and Impedance (Zo)

### Coplanar Waveguide w/Ground

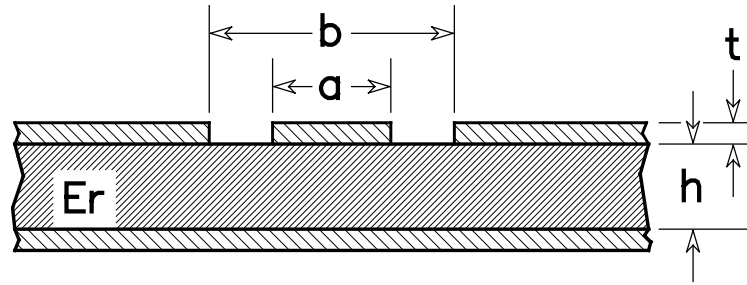

- ◆ In Reality, Microstrip Transmission Line in the RF / Microwave Arena is CPWG.

39

## RF / Microwave Design - Line Types and Impedance (Zo)

### Coplanar Waveguide w/Ground

$$Z_0 = \frac{120\pi}{2.0\sqrt{\epsilon_{eff}}} \cdot \frac{1.0}{\frac{K(k)}{K(k')} + \frac{K(k1)}{K(k1')}}}$$

$$k = a / b$$

$$k' = \sqrt{1.0 - k^2}$$

$$\epsilon_{eff} = \frac{1.0 + \epsilon_r \frac{K(k')}{K(k)} \frac{K(k1)}{K(k1')}}{1.0 + \frac{K(k')}{K(k)} \frac{K(k1)}{K(k1')}}}$$

$$k1' = \sqrt{1.0 - k1^2}$$

$$k1 = \frac{\tanh\left(\frac{\pi a}{4.0h}\right)}{\tanh\left(\frac{\pi b}{4.0h}\right)}$$

40

## RF / Microwave Design - Line Types and Impedance ( $Z_o$ )

### Coplanar Waveguide w/Ground

- ◆ To Avoid Microstrip Mode,  $h > b$  and Left & Right Ground Extend Away from 'a' by More than 'b'.
- ◆  $Z_o$  of CPWG is Increased as Dielectric Thickness Increases. Opposite of CPW.
- ◆ If 'h' is Large, CPW and CPWG Behave in Similar Fashion.

41

## RF / Microwave Design - Line Types and Impedance ( $Z_o$ )

### CPWG versus Microstrip

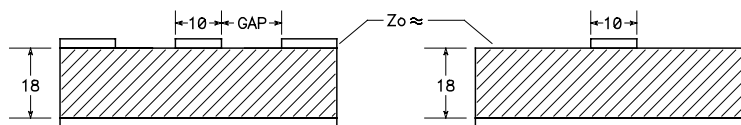

$$\epsilon_r = 4.2 - Z_o = 94 \text{ Ohms (At Gap = 30)}$$

$$(\epsilon_{eff} = 2.92 \text{ (CPWG) and } 2.95 \text{ (MS)})$$

$$\epsilon_r = 2.5 - Z_o = 115 \text{ Ohms (At Gap = 27)}$$

$$(\epsilon_{eff} = 1.89 \text{ (CPWG) \& } 1.92 \text{ (MS)})$$

- ◆ Beyond Gaps shown above, CPWG like Microstrip.

42

## RF / Microwave Design - Line Types and Impedance ( $Z_0$ )

### Edge Coupled CPW (CP Differential Pair)

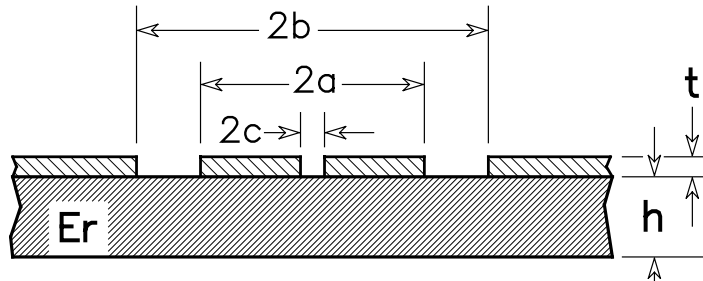

(Equations in Wadell- Page 194-195)

- ◆ Gives an Extra Degree of Signal-to-Noise Isolation Over standard CPW. (w/o Plane, Fields are Large)

43

## RF / Microwave Design - Line Types and Impedance ( $Z_0$ )

### Edge Coupled CPWG (CP Diff Pair w/Grnd)

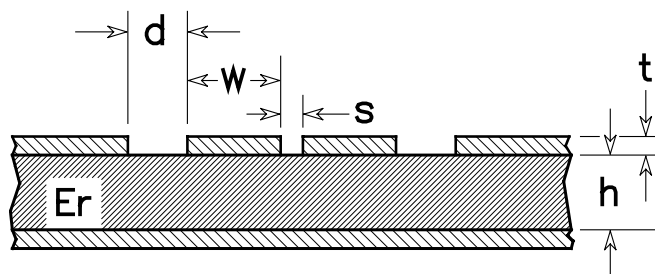

(Equations in Wadell- Page 197-198)

- ◆ Much Better Field Containment than Coupled CPW. Better yet in Edge Couple Stripline.

44

## RF / Microwave Design - Line Types and Impedance ( $Z_0$ )

### Slotline

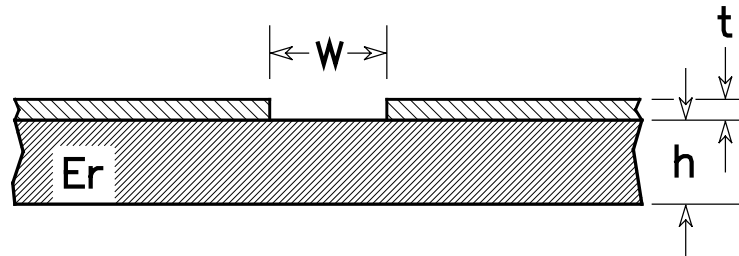

- ◆ Acts Like Waveguide with Air DK.

(Equations in Wadell- Pages 156-160)

45

## RF / Microwave Design - Line Types and Impedance ( $Z_0$ )

### Other Configurations

- ◆ 3 Line Coplanar Strip w & w/o Ground.
- ◆ Microstrip w/ Limited Width Plane (and/or) Limited Width Dielectric.
- ◆ Metal Plate or Shield Covered CPW/CPWG.
- ◆ Metal Plate or Shield Covered Slotline.
- ◆ Offset CPW or CPWG.
- ◆ Etc, etc. - See Wadell or Gupta, Garg, .....

46



## **RF / Microwave Design - Line Types and Impedance (Zo)**

### Zo Calculations

- ◆ Use Equations Given or Wadell or Gupta.
- ◆ Use H.P. AppCAD (DOS and/or Windows).
- ◆ Use Rogers Corp. MWI (Dr R. Trout).
- ◆ Buy Field Solver (2D or 3D) Based Zo Calculator (i.e.- POLAR Ltd.)
- ◆ Don't use Equations or Calcs for Dig Lay-out that Don't Comp for Coplanar Effects.

47



## **RF / Microwave Design - Line Types and Impedance (Zo)**

### Tpd, Capacitance and Inductance Calcs

(For all previous Configurations)

$$Tpd = \sqrt{\epsilon_{eff}} / c(\text{spd of light})$$

$$C = Tpd / Zo$$

$$L = Zo^2 \times C \text{ (or } Tpd \times Zo)$$

48





## **RF / Microwave Design -** **Integral Components**

- ◆ Components can be Designed into the PC Board Utilizing the Right Configuration of Lines and Shapes to form-
  - ◇ Inductors
  - ◇ Capacitors
  - ◇ Couplers (Similar to Transformer)
  - ◇ Resistors (Very Small Value)
  - ◇ Filters

49



## **RF / Microwave Design -** **Integral Components**

- ◆ Capacitor formed by 2 Copper Plates separated by PCB Dielectric (Free Component) -

$$C = \epsilon_r \times \epsilon_0 \times (A/h)$$

Where:  $\epsilon_r$  - DK of PCB Material

$\epsilon_0$  - Permittivity of Space  
( $2.25 \times 10^{-13}$  ferrads/in.)

A - Area of Plate (L x W)

h - Dielectric Thickness

50

## RF / Microwave Design - Integral Components

### ◆ Interdigital Capacitor-

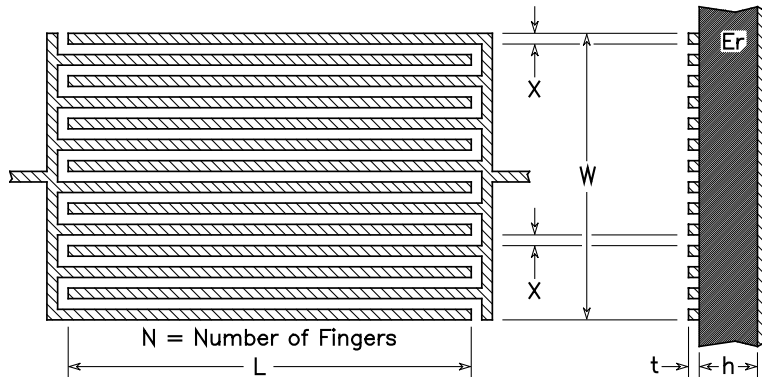

51

## RF / Microwave Design - Integral Components

### ◆ Interdigital Capacitor

$$C_2 = \frac{\epsilon_r + 1.0}{w} L[(N - 3.0)A1 + A2] \text{ (pF / in)}$$

$$A1 = \left[ 0.3349057 - 0.15287116 \left( \frac{t}{X} \right) \right]^2$$

$$A2 = \left[ 0.50133101 - 0.22820444 \left( \frac{t}{X} \right) \right]^2$$

(Equation valid for  $h > w/N$ )

52

## RF / Microwave Design - Integral Components

### ◆ Multilayer Capacitor -

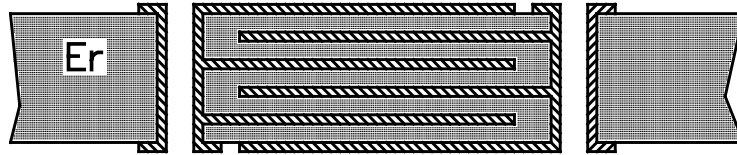

$$C = \frac{0.229 \epsilon_r A (n - 1.0)}{d} \quad (\text{pF})$$

where:

A = area of planes in square inches

n = number of conductor layers

d = plate spacing

53

## RF / Microwave Design - Integral Components

### ◆ Inductor- Inline Inductor is formed by a Very Thin, High Impedance Trace.

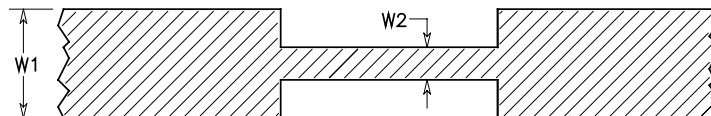

◆ Length Must be Shorter than Critical Length to Prevent Reflections. Can Remove Plane(s) to Boost Inductance.

◆  $L = Z_0^2 \times C$  or  $T_{pd} \times Z_0$  (Many Equations available. This is Extremely Accurate.)

54

## RF / Microwave Design - Integral Components

### ◆ Spiral Inductors -

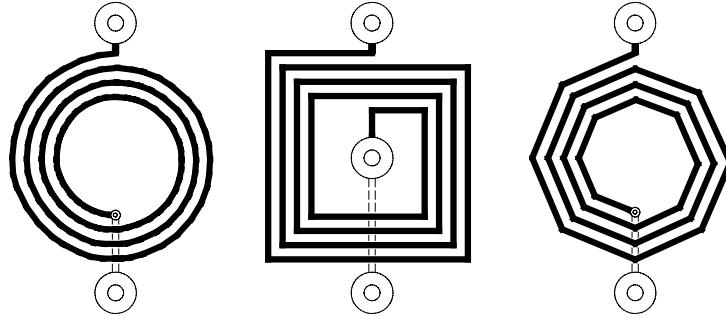

(Equations in Wadell- Pages 392-406)

55

## RF / Microwave Design - Integral Components

### Other Discrete Examples

#### CPW & CPWG Shunt Capacitor -

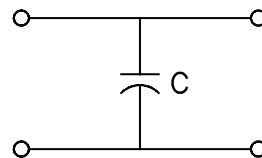
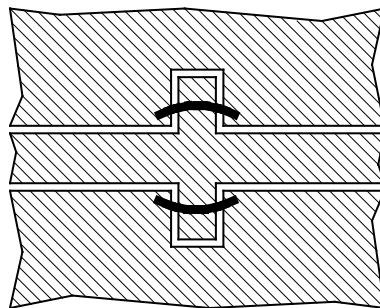

56

**RF / Microwave Design -**  
**Integral Components**

Other Discrete Examples

CPW & CPWG Series Capacitor -

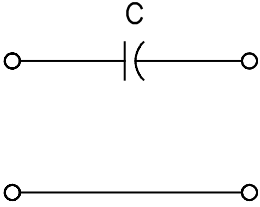
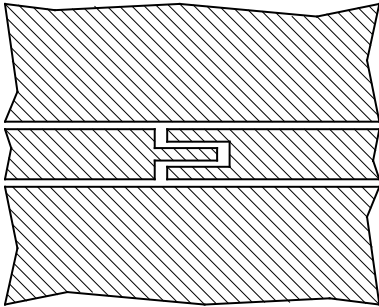

**RF / Microwave Design -**  
**Integral Components**

Other Discrete Examples

CPW & CPWG Shunt Inductor -

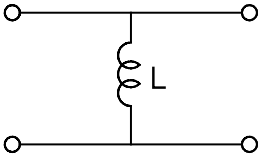
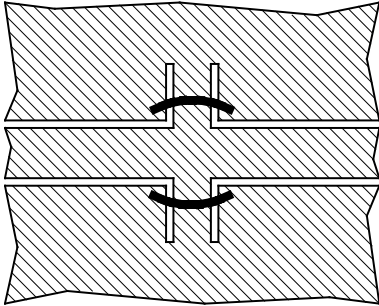

## RF / Microwave Design - Integral Components

### Other Discrete Examples

CPW & CPWG Series Inductor -

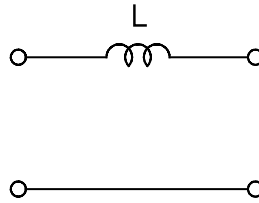
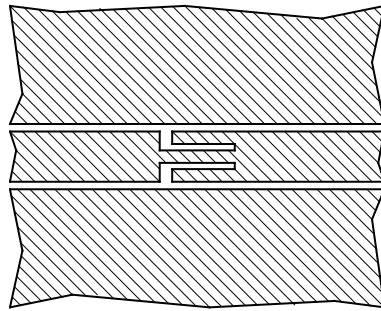

59

## RF / Microwave Design - Integral Components

### Other Discrete Examples

Gap in Centered Stripline Conductor-

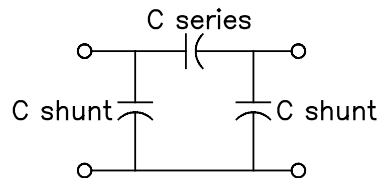
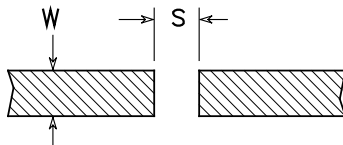

(Equations in Wadell - Pages 360-361)

60

## RF / Microwave Design - Integral Components

### Other Discrete Examples

#### Round Hole in Centered Stripline -

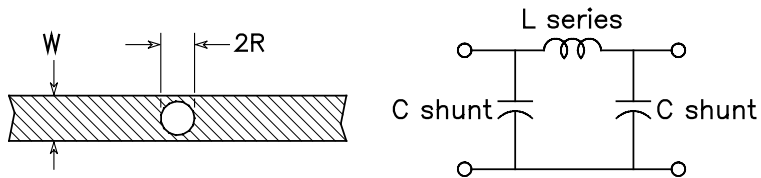

(Equations in Wadell - Pages 361-362)

61

## RF / Microwave Design - Integral Components

### Other Discrete Examples

#### Rectangular Hole in Centered Stripline -

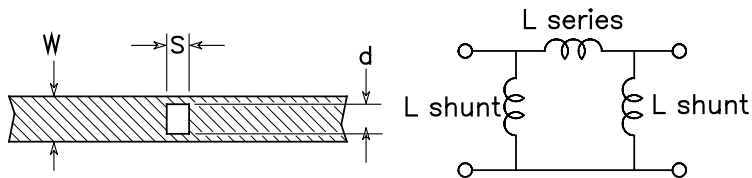

(Equations in Wadell - Pages 362-364)

62

## RF / Microwave Design - Integral Components

- ◆ Filters can be made from the L & C Circuit Elements discussed.
- ◆ The Following Illustrates Various Filters that can be Constructed.

63

## RF / Microwave Design - Integral Components

- ◆  $\lambda/4$  Stub is Series Resonant Circuit at Frequency.
- ◆ Circuit Shorts to Ground at  $\lambda/4$ ,  $3/4\lambda$ , etc.
- ◆ Open Circuit at DC,  $\lambda/2$ ,  $\lambda$ , etc.

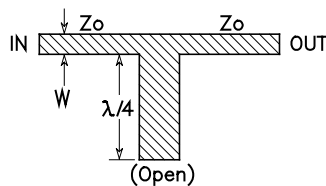

Microstrip Open-Stub

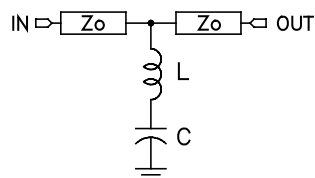

Microstrip Open-Stub Equivalent  
Circuit at Resonant Frequency

- ◆ 2W Wide for High Q and to Prevent Reflections. 64



## RF / Microwave Design - Integral Components

- ◆ Open Stubs (one just shown) have Narrow Frequency Over which they Short to Ground.
- ◆ Flaring the Stub Increases Frequency Response.

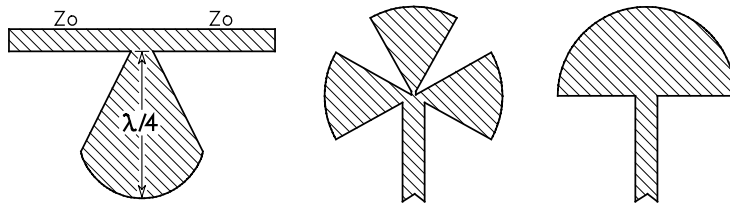

(Equations in Wadell - Pages 304-305)

65

## RF / Microwave Design - Integral Components

- ◆  $\lambda/4$  Stub, Shorted to Ground, is Parallel Resonant Filter at Frequency of Interest.
- ◆ Circuit Shorts to Ground at DC,  $\lambda/2$ ,  $\lambda$ , etc.
- ◆ Open Circuit at  $\lambda/4$ ,  $3/4 \lambda$ , etc.

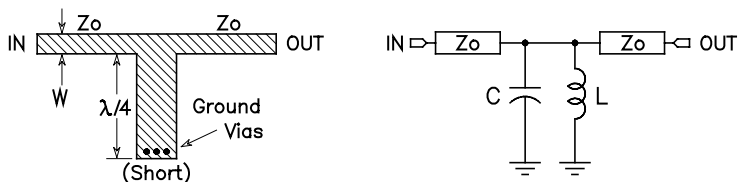

Microstrip Shorted-Stub

Microstrip Shorted-Stub Equivalent Circuit at Resonant Frequency

66

## RF / Microwave Design - Integral Components

### ◆ Low Pass Filter -

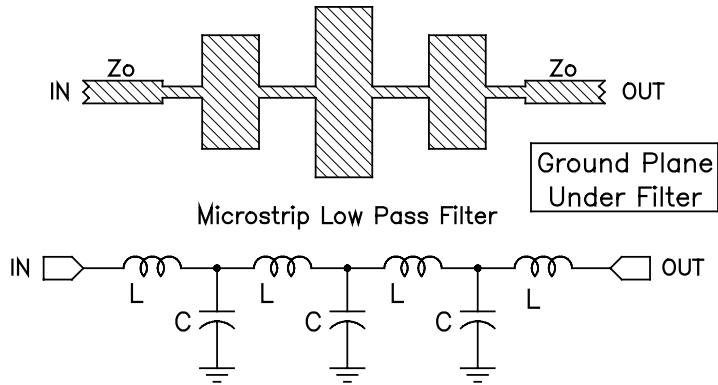

67

## RF / Microwave Design - Integral Components

### ◆ Edge Coupled Band Pass Filter -

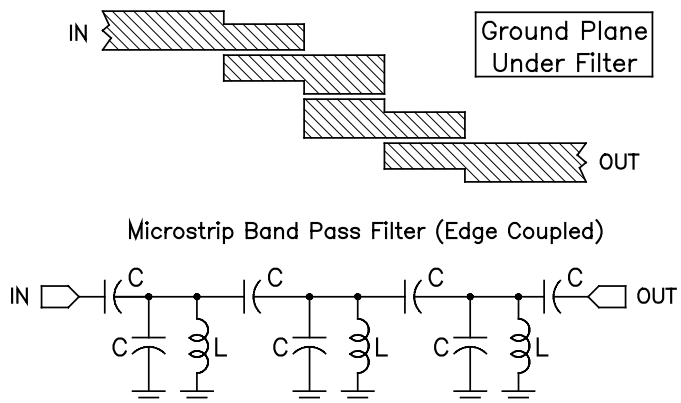

68

## RF / Microwave Design - Integral Components

### ◆ End Coupled Band Pass Filter -

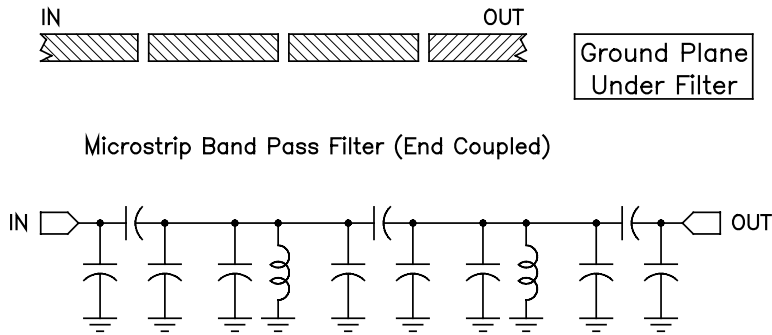

69

## RF / Microwave Design - Integral Components

### ◆ Directional Coupler -

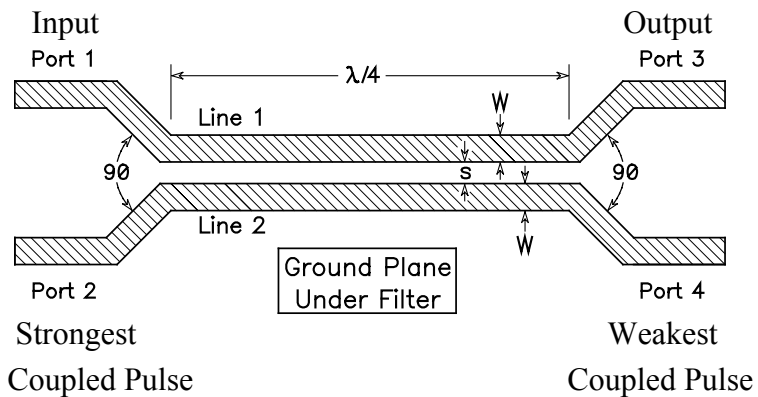

70



## **RF / Microwave Design - Integral Components**

- ◆ Directional Coupler can be used as -
  - ◇ A Filter at  $\lambda/4$  Frequencies.
  - ◇ Non Loading Method to Transfer Energy to Another Circuit.
  - ◇ A Method to Monitor Power Sent to Port 3.
  - ◇ Closed Loop Feedback Control.
  - ◇ A Non-Loading way to Measure a Signal with an Oscilloscope.

71



## **RF / Microwave Design - Integral Components**

- ◆ Resistors -
  - ◇ Impractical when made from PCB Copper.
  - ◇ Requires Extremely Long Lines to achieve Resistance of a Few Ohms.
- ◆ One Exception -
  - ◇ When Very Small 'R' is needed to Measure a Very Large Current.

72

## RF / Microwave Design - Layout Techniques and Strategies

- ◆ Low Level Analog, RF/Microwave and Digital Sections Must be Separated.
- ◆ Divide RF/Microwave Section into Circuit Groups (VCO, LO, Amps, etc.).
- ◆ Place High Frequency Components First, to Minimize Length of Each RF Route (Orientation for Function More Critical than DFM).
- ◆ Place Highest Frequency Components Nearest Connectors.

73

## RF / Microwave Design - Layout Techniques and Strategies

- ◆ Don't Locate Unrelated Outputs and Inputs Near Each Other. Especially Multi-Stages Winding Back on One Another.
- ◆ When Either the Output or Input to Amplifiers Must be Long, Choose the Output.

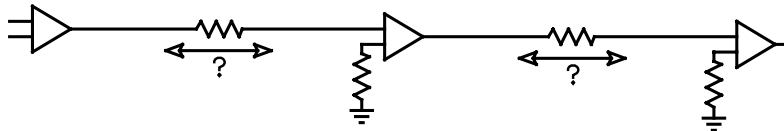

(Where Do Resistors Go?)

74



## **RF / Microwave Design - Layout Techniques and Strategies**

- ◆ Remember, Trace Impedance ( $Z_0$ ) is a Critical Factor in the Effort to Control Reflections.
- ◆ Impedance must Match Driver and Load.
- ◆ In Traces Shorter than  $1/20\text{th } \lambda$  Long,  $Z_0$  Matching is Usually Not Important.

75



## **RF / Microwave Design - Layout Techniques and Strategies**

- ◆ When Pull-up Resistors or Inductors are Used on the Outputs of Open Collector Devices, Place the Pull-up Component Right At the Output Pin it's Pulling.
- ◆ Also, make Certain to Decouple the Pull-up, in Addition to the Main Power Pins of the IC.

76



## **RF / Microwave Design - Layout Techniques and Strategies**

- ◆ Inductors have Large Magnetic Fields Around Them-
  - ◇ They Should Not be Placed Close Together, when In Parallel (Unless Intent is to have Their Magnetic Fields Couple).
  - ◇ Separate Inductors by One(1) Times Body Height (Min) -(OR)-
  - ◇ Place Perpendicular to One Another.

77



## **RF / Microwave Design - Layout Techniques and Strategies**

- ◆ Keep “ALL” Routes Confined to the Stage or Section to which they are Assigned-
  - ◇ Digital Traces in the Digital Section. Period.
  - ◇ Low Level Analog in Low Level Analog.
  - ◇ RF / Microwave in RF / Microwave Section.
- ◆ Don't Route Traces into Adjoining Sections.

78



## **RF / Microwave Design - Layout Techniques and Strategies**

- ◆ Short RF Traces should be on Component Side of Board, Routed to Eliminate Vias.
- ◆ Next Layer Below RF Traces to be Ground.
- ◆ Minimizing Vias in RF Path Minimizes Breaks in Ground Plane(s)-
  - ◇ Minimizes Inductance.
  - ◇ Helps Contain Stray Electric & Magnetic Fields.
- ◆ Control Lines can be Long, but Must Route Away from RF Inputs.

79



## **RF / Microwave Design - Layout Techniques and Strategies**

- ◆ RF / Microwave Lines Must be Kept Away From One Another By Min Distances to Prevent Unintended Coupling & Crosstalk.
- ◆ Minimum Spacing is a Function of How Much Coupling is Acceptable.
- ◆ Equations in Wadell, Pages 181 - 254.
  - ◇ Good for Crosstalk, Directional Couplers, Odd or Even Mode Coupled (Diff) Lines.

80



## RF / Microwave Design - Layout Techniques and Strategies

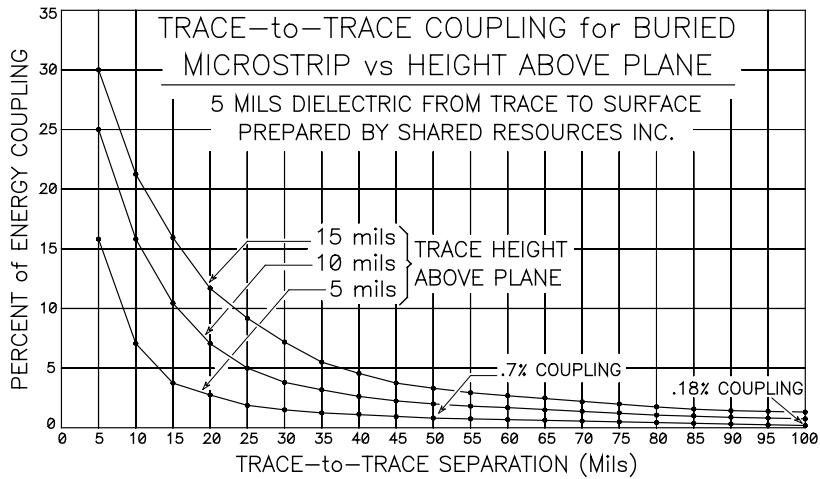

## RF / Microwave Design - Layout Techniques and Strategies

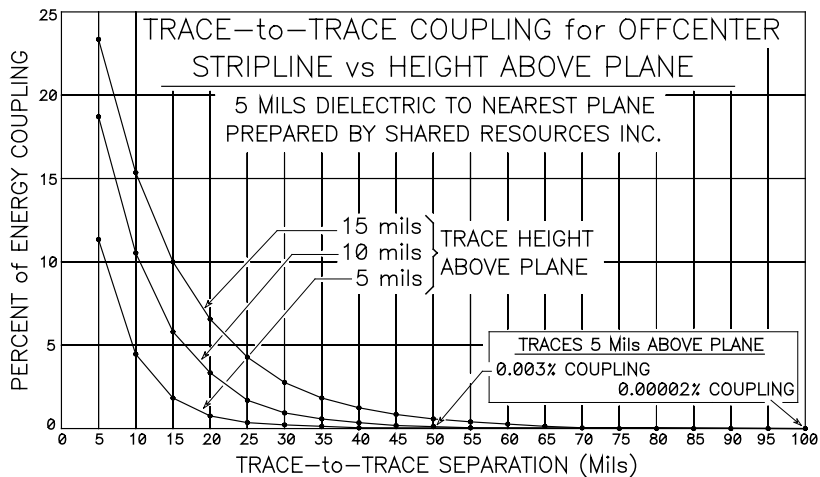



## **RF / Microwave Design - Layout Techniques and Strategies**

- ◆ When Circuit MUST Loop Back on Itself and Outputs end up Near Inputs -
  - ◇ Place Ground Copper (20 H Wide) Between Sections, Most specifically Between Inputs and Outputs.
  - ◇ Use 20 H Wall if Copper is Less than 20 H Wide.
  - ◇ Attach Ground Copper to Board Planes Every 1/20th Wavelength of Principal Frequency.
- ◆ Use Same Methods when Unrelated Inputs and Outputs Must Be Near One Another.

83



## **RF / Microwave Design - Layout Techniques and Strategies**

- ◆ In Multilayer Boards, When Signals Must Change layer, Route in Layer Pairs -
  - ◇ Layer 1 Signals Reference Ground on Layer 2.
  - ◇ When Direction Change Needed, Via Signal to Layer 3.
- ◆ i.e.: First Four(4) Layers of a Board -
  - Layer 1 (Signal - X Direction)
  - Layer 2 (Ground Plane)
  - Layer 3 (Signal - Y Direction)
  - Layer 4 (Ground Plane)

84



## **RF / Microwave Design - Layout Techniques and Strategies**

- ◆ **Components Connecting to Ground -**
  - ◇ Flood Component Lead with Surface Ground. (Let Soldermask or Mask Dam Define Pad).
  - ◇ Ground Vias as Close to Component Lead as Possible. Preferably ON Component Lead.
  - ◇ Multiple Vias (3, 4, etc.) Reduce Inductance and Help Eliminate Ground Bounce.
  - ◇ Direct Connection. No Thermal Vias.
  - ◇ Must attempt to permit Proper Solder Reflow.

85



## **RF / Microwave Design - Layout Techniques and Strategies**

- ◆ **Ground: All Designs, 2 Layer or Multilayer -**
  - ◇ Unused Areas of Every Layer to be Poured with Ground Copper.
  - ◇ Ground Copper and All Ground Planes through Board to be Connected with Vias Every 1/20th Wavelength Apart (Where Possible).
  - ◇ Vias Closer than 1/20th  $\lambda$  are Better.
  - ◇ Very Critical Circuits - Vias Closer than 1/20th  $\lambda$  Help Reduce Noise.
  - ◇ Direct Connect Vias. NO Thermal Vias.

86

## RF / Microwave Design - Layout Techniques and Strategies

### ◆ Ground:

- ◇ 'Copper Pours' Too Small to have Vias Must be Removed (Can Act as Antenna).
- ◇ Arrange Poured Ground Around Signals to Completely Surround Signals -

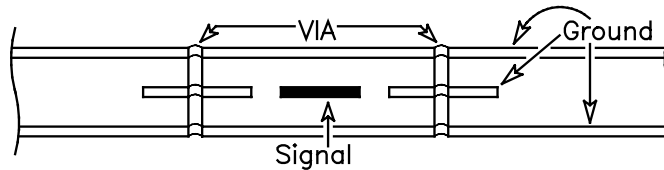

- ◇ Ground Vias to Include Picket Fencing at Edge of Board. In Very Critical Circuits, Plate Board Edge. <sup>87</sup>

## RF / Microwave Design - Layout Techniques and Strategies

### ◆ Ground:

- ◇ By Maintaining Isolation Between Circuits, Do Not Split Ground Plane.
- ◇ Attach Ground to Case Continuously.
- ◇ One Exception is Ground for Cable Shields.

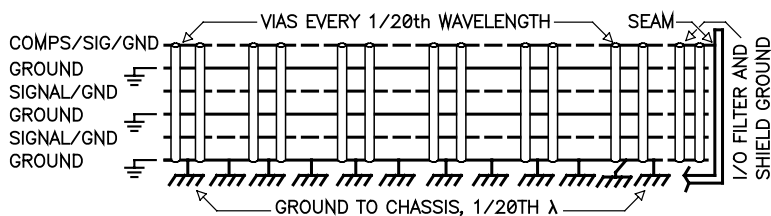

## RF / Microwave Design - Layout Techniques and Strategies

- ◆ Mismatched Source and Load Impedance:  
If Line can be  $\lambda/4$  Long -

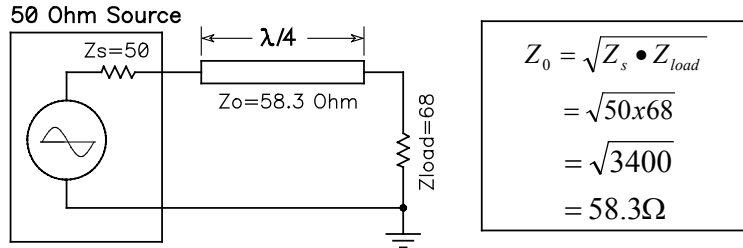

( $\lambda/4$  is Calculated From Frequency of Source  
and Eeff of the Transmission Line.)

89

## RF / Microwave Design - Layout Techniques and Strategies

- ◆ Mismatched Source and Load Impedance:  
If Line Can NOT be  $\lambda/4$  Long -

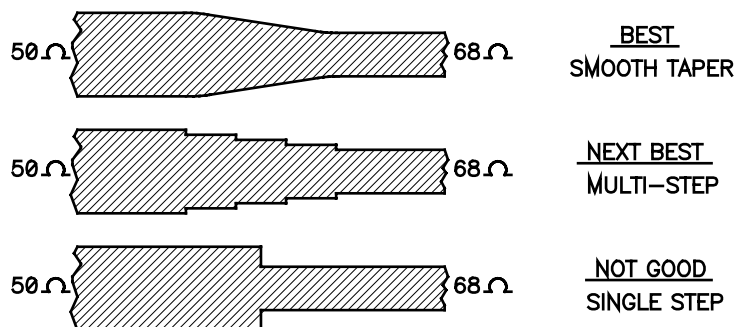

90

### Transmission Line Impedance Matching By Single Stub Tuning

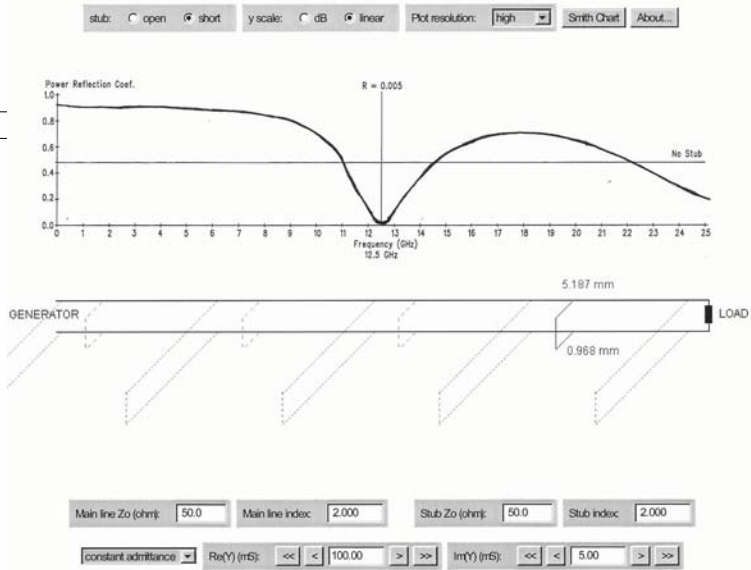

Mismatched Source and Load Impedance

### Transmission Line Impedance Matching By Single Stub Tuning

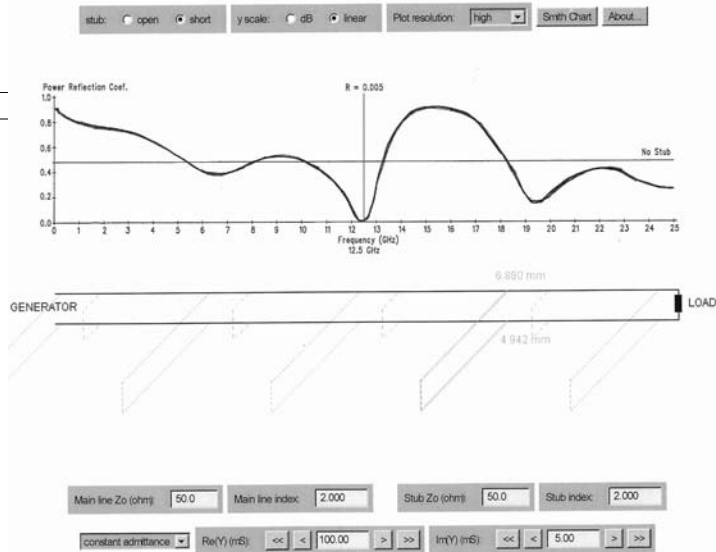

## RF / Microwave Design - Layout Techniques and Strategies

### ◆ Trace Corners -

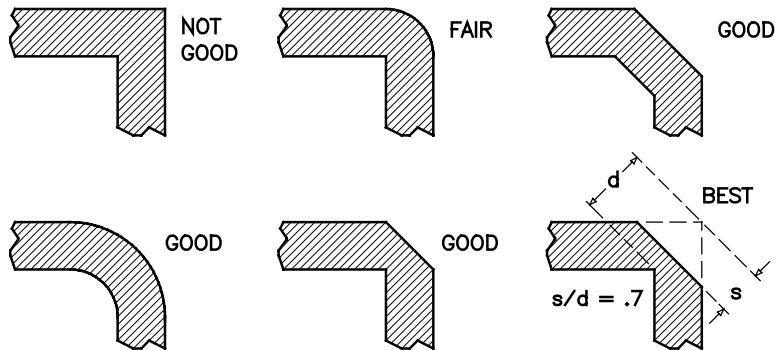

93

## RF / Microwave Design - Layout Techniques and Strategies

### ◆ Trace Corners -

#### Others Considered Fair to Good

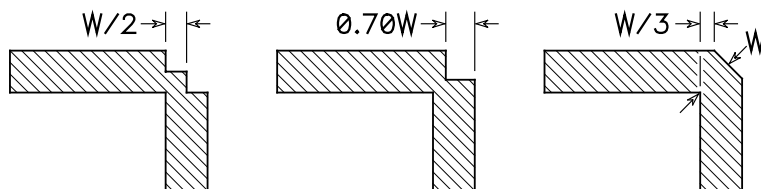

94

## RF / Microwave Design - Layout Techniques and Strategies

◆ ‘T’-Junctions:

Ideal is the Wilkinson Splitter-

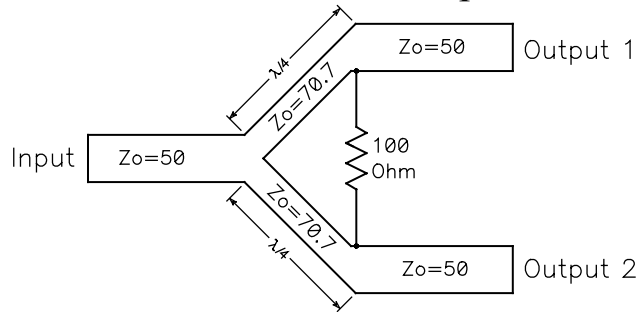

## RF / Microwave Design - Layout Techniques and Strategies

◆ ‘T’-Junctions (Acceptable):

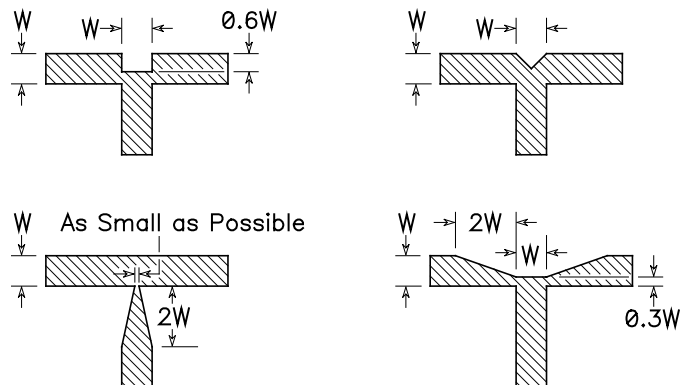



## RF / Microwave Design - Layout Techniques and Strategies

### ◆ Impedance of Vias-

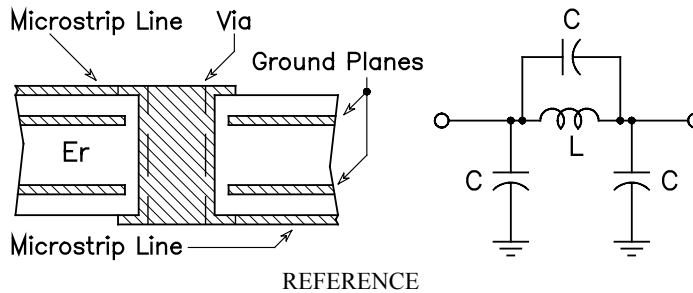

Wang, Taoyun, *et al.*, "Quasi-static Analysis of a Microstrip Via Through a Hole in a Ground Plane," *IEEE Transactions on Microstrip Theory and Techniques*, Vol. MTT-36, No. 6, June 1988, pp. 1007-1013.

97

## RF / Microwave Design - Layout Techniques and Strategies

- ◆ Copper Patches can be placed Next to Signal Traces to Create Attachment Points for Wire or Solder to Create Tuning 'C' or 'L' -

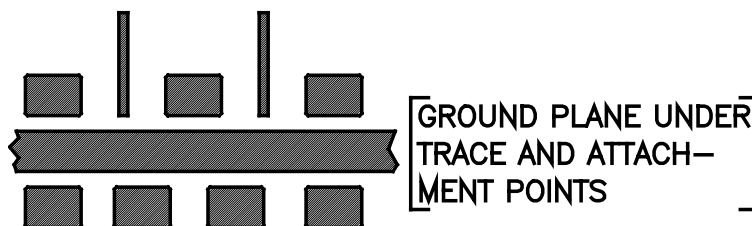

98



## **RF / Microwave Design - Layout Techniques and Strategies**

- ◆ Long Microstrip Traces can be Antenna for Radiation of EMI or Reception of Noise.
- ◆ Ideal Trace Antenna is  $1/4$  Wavelength Long.
- ◆ In Designs where Stripline is available, Keep Outer Layer Traces under Critical Length.

99



## **RF / Microwave Design - Power Bus**

- ◆ Route Power in 2 Layer Board (Microstrip, CPW or CPWG) (Only Plane is Ground).
- ◆ In Multilayer Boards Power Can be Plane if One(1) Voltage or Split Plane if Several Voltages.
- ◆ In Multilayer Board with Many Voltages, Power is Usually Routed on One (1) or more Layers.

100



## RF / Microwave Design - Power Bus

- ◆ When Routed, Make Power Grid if two(2) or more Layers are used. Grid Most Closely Emulates Behavior of a Plane.
- ◆ Due to Self Resonance of Decoupling Caps, selected to match Frequency of Operation, Wide Routes work as well in Analog Circuits to distribute Power as do Planes.

101



## RF / Microwave Design - Power Bus

- ◆ Power is generally ----- Ground  
Routed between -- -- -- -- -- Power  
Ground Planes to ----- Ground  
help Lower Noise Coupling in Power Bus.
- ◆ Ground Planes are **Always** Continuous.  
(Only Split at Front Panel for Cable Shields  
and Filters).

102

## RF / Microwave Design - Power Bus

- ◆ Power Decoupling Consists of Low Pass Filter with Several Capacitors to Cover a Broad Range of Frequencies and Currents-

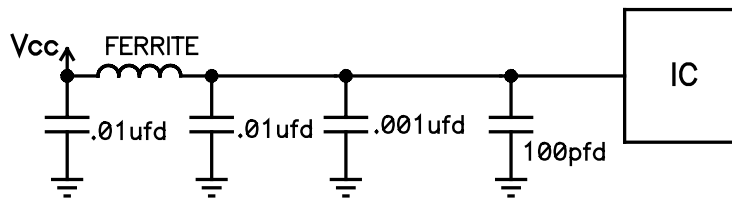

(Notice Order of Capacitors)

103

## RF / Microwave Design - Power Bus

- ◆ Select Capacitors in Low Pass Filter so Smallest Value has Self Resonance of Operating Frequency of Circuit.
- ◆ Largest Value selected to carry Maximum Current Drawn by IC.
- ◆ Capacitors Progress Upward in Value in Steps of 10 Times.
- ◆ Place Caps w/ Smallest Value Near IC, then Next Largest Value, etc.

104

## RF / Microwave Design - Power Bus

- ◆ Place Smallest Value Capacitor AT Power and Ground Pins of IC.
- ◆ Ideally, Capacitors are in Parallel with Power & Ground Pins of IC.
- ◆ When Not Possible, Place Smallest Value Capacitor at Power Pin of IC and as Near Ground Pin as Possible.
- ◆ Attach Caps w/ Wide Traces & Gnd Floods.
- ◆ Many Vias, Large Enough to Carry Current. <sup>105</sup>

## RF / Microwave Design - Power Bus

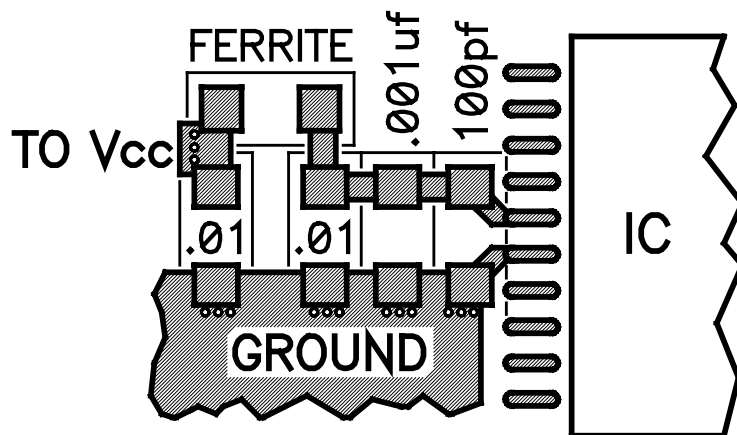



## **RF / Microwave Design - Board Stack-Up**

- ◆ In 2 Layer Boards, Dielectric Will be Tightly Controlled (And Usually Not .062”).
- ◆ Dielectrics of .015-.025” Thick, Common.
- ◆ In ALL Designs, One Ground Plane MIN.
- ◆ In CPW, to create Continuous Ground, Strap Across Sig Lines From Ground to Ground.
- ◆ In Microstrip / CPWG, Pour Ground on Sig Side, w/ Continuous Ground Opposite Side.<sup>107</sup>



## **RF / Microwave Design - Board Stack-Up**

- ◆ In Multilayer Board, have Ground on Every Other Layer.
- ◆ Signals Located on Either Side of Ground Plane Must Cross at Right Angles.  
(Planes give 60 dB of Isolation of Currents on Either Side. 60 dB May Not be Enough in RF / Microwave Circuit, Hence Right Angle Routing.)
- ◆ Remember, Route in Layer Pairs.

## RF / Microwave Design - Board Stack-Up

◆ Typical High Layer Count Board-

Layer 1	-----	Devices, Short Signals, Ground
Layer 2	-----	Ground Plane
Layer 3	-----	Signals, Ground Pour
Layer 4	-----	Ground Plane
Layer 5	-----	Signals, Ground Pour
Layer 6	-----	Ground Plane
Layer 7	-----	Power Plane or Power Routes
Layer 8	-----	Ground Plane
Layer 9	-----	Signals, Ground Pour
Layer 10	-----	Ground Plane
Layer 11	-----	Signals, Ground Pour
Layer 12	-----	Ground Plane

109

## RF / Microwave Design - Board Stack-Up

◆ When RF Stages Located on Opposite Sides of a Board, Blind Vias May Be Needed in Each Stage to Effectively Create Back-to-Back Boards-

Example-

Layer 1	-----	Devices, Short Signals, Ground
Layer 2	-----	Ground Plane
Layer 3	-----	Signals, Power, Ground Pour
Layer 4	-----	Ground Plane
Layer 5	-----	Ground Plane
Layer 6	-----	Signals, Power, Ground Pour
Layer 7	-----	Ground Plane
Layer 8	-----	Devices, Short Signals, Ground

110



## **RF / Microwave Design - Signal Attenuation**

### Increases or Decreases Pulse Amplitude -

- 1) Reflections (Return Loss / VSWR - Critical).
- 2) Signal Cross Talk (Critical in RF).
- 3) Reference Voltage Accuracy (Critical in RF).
- 4) Power Bus Noise (Minimal- Filtered).
- 5) Ground/Vcc Bounce (Minimal in RF).
- 6) Skin Effect (Resistive Loss in Conductor).
- 7) Loss Tangent (Property of PCB Dielectric).

111



## **RF / Microwave Design - Skin Effect**

- ◆ Increases Resistive Signal Loss (Adds Heat).
- ◆ Losses Increase with Increased Frequency.
- ◆ Amplitude Loss in Analog Circuits.
- ◆ Most effected by Line Width and Length.
- ◆ Can be a problem above 10's of MHz in Analog circuits.

112





## RF / Microwave Design - Skin Effect

$$R = \frac{\rho \cdot \text{Length}}{\text{AREA}_{\text{eff}}}$$

$$\rho = 6.787 \times 10^{-7} \text{ ohm-in}$$
$$\rho = 1.724 \times 10^{-5} \text{ ohm-mm}$$

$$\text{AREA}_{\text{eff}} = 2(w + t) \cdot SD$$

$w$  - Trace Width  
 $t$  - Trace Thickness

$$SD = \frac{2.6}{\sqrt{f}}$$

$SD$  - Skin Depth in Inches  
 $f$  - Frequency in Hertz

$$SD = \frac{66}{\sqrt{f}}$$

$SD$  - Skin Depth in mm  
 $f$  - Frequency in Hertz

113



## RF / Microwave Design - Skin Effect

- ◆ “R” from equation is ONLY Accurate for Centered Stripline configuration.
- ◆ “R” of all other Transmission Line configurations must be adjusted due to ‘Proximity Effect’.
  - ◇ Microstrip (50 to 75 ohm) - Multiply “R” by 1.70
  - ◇ Embedded Microstrip (50-75) - Multiply “R” by 1.85
  - ◇ Offset Stripline -
    - Adjust “R” based on Factor Determined by Percent of Offset from Center (OR)
    - Adjust Percent of Attenuation of Signal based on Percent of Coupling to Nearest Plane.

114

## RF / Microwave Design - Skin Effect

- ◆ Attenuation of the Signal is a Function of 'Skin Effect' Resistance and Current in the Transmission Line -

$$\text{Atten}(\text{volts}) = R \cdot I$$

$$\text{Where - } I = \frac{V_{\text{DRIVER}}}{Z_{\text{O LOADED}}}$$

$$\text{Atten}(\text{dB}) = \frac{2R \cdot 3\text{dB}}{Z_{\text{O LOADED}}}$$

115

## RF / Microwave Design - Loss Tangent ( $\tan(\delta)$ )

- ◆ Loss of Signal into PCB Material (Increases Heat).
- ◆ Function of Molecular Structure of PCB Material.
- ◆ Losses Increase with Increased Frequency.
- ◆ Amplitude Loss in Analog Circuits.
- ◆ Worse in FR4 (Alternative Materials available).
- ◆ Material Selection- Weigh Performance and Price.
- ◆ Can be problem above 10's of MHz in Analog ckt.

116

## RF / Microwave Design - Loss Tangent ( $\tan(\delta)$ )

The amount a signal is attenuated from Loss Tangent can be determined with the equation -

$$\alpha = 2.3 f \cdot \tan(\delta) \cdot \sqrt{\epsilon_{eff}}$$

Where :  $\alpha$  = Attenuation in dB / Inch.

$f$  = Frequency in GHz.

$\tan(\delta)$  = Loss Tangent of Material.

$\epsilon_{eff}$  = Effective Relative Er of Material.  
(Er for Stripline)

117

## - Signal Attenuation -

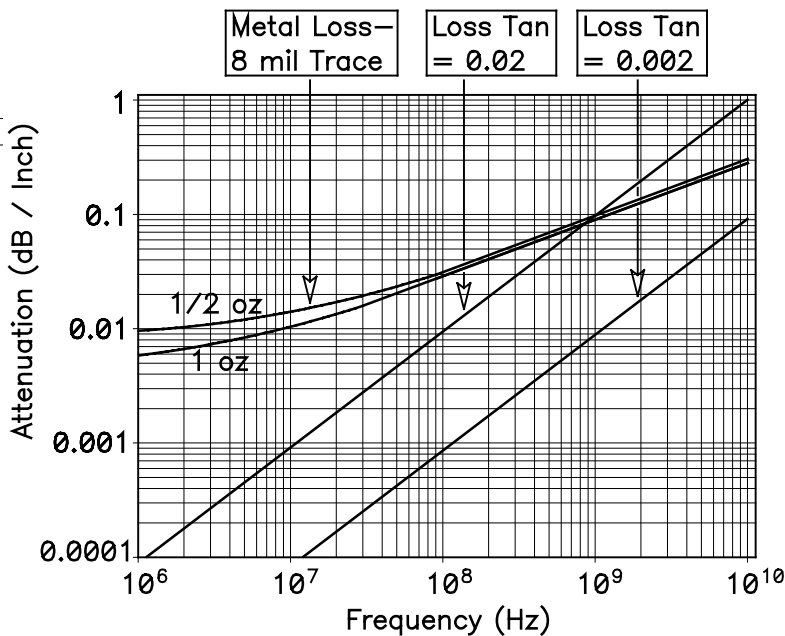

118

## **RF / Microwave Design - Shields and Shielding**

- ◆ Use a Metal Can, Grounded Shield when -
  - ◇ Circuits are so Close Together that Noise Coupling Naturally Occurs.
  - ◇ EMI is Extreme and Cannot be Contained.
  - ◇ Circuit is So Sensitive that Normal, Ambient EMI Levels affect Performance.
- ◆ Problems! Shields -
  - ◇ Use up Valuable Board Space.
  - ◇ Are Expensive.
  - ◇ Make Trouble Shooting and Repair Very Difficult. <sup>119</sup>

## **RF / Microwave Design - Shields and Shielding**

- ◆ Shield Cost -
  - ◇ Least Expensive is Off-the-Shelf.
  - ◇ Next Lowest Cost is Photo Etched.
- ◆ Resolve Trouble Shooting / Repair Issues-
  - ◇ Tabs Every  $1/20\text{th } \lambda$  instead of Continuous Connection to Ground on Circuit Board.

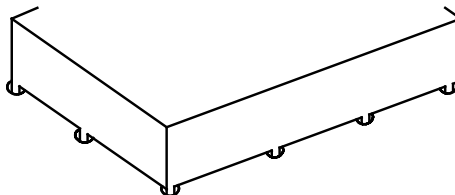



## **RF / Microwave Design - Shields and Shielding**

- ◆ Traces Running out of Shielded Area to be Routed on Inner Layers, if possible.
- ◆ When Routing from Shield Area on Same Layer as Shield, have a Minimum Opening in Shield Side Wall.
- ◆ Cable Exiting Shield Must have 360 degree Attachment of Cable Shield to Metal Can.
- ◆ Avoid Other Openings in Shields.

121



## **RF / Microwave Design - Shields and Shielding**

- ◆ Open Soldermask Under Shield Edges enough to allow Good Solder Attachment of Shield Walls to Ground Plane.
- ◆ Alternative to Soldered Shield- Make Case Lid with Fins/Vanes Long enough to Reach PCB Surface and Contact Ground to Create Compartments inside Enclosure.
- ◆ Equations for Shielding Effectiveness in Wadell, Pages 117 -123.

122

## RF / Microwave Design - Example PC Boards

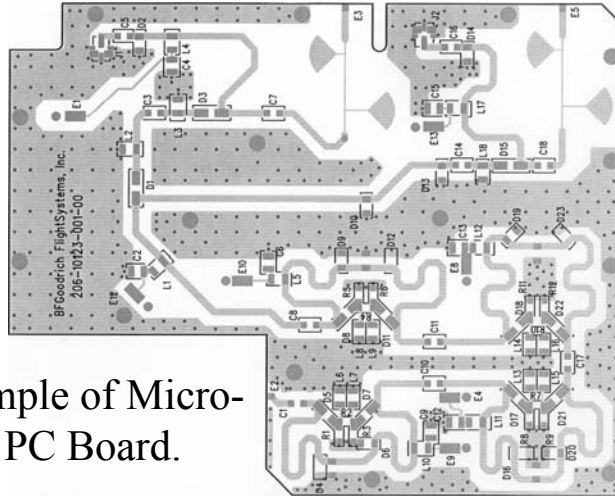

Example of Microstrip PC Board.

123

## RF / Microwave Design - Example PC Boards

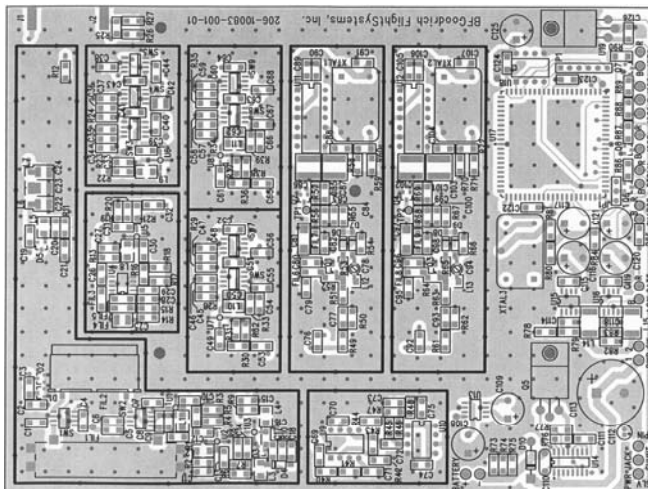

Typical Multi-Layer Microwave PC Board.

124

## **RF / Microwave Design - Example PC Boards**

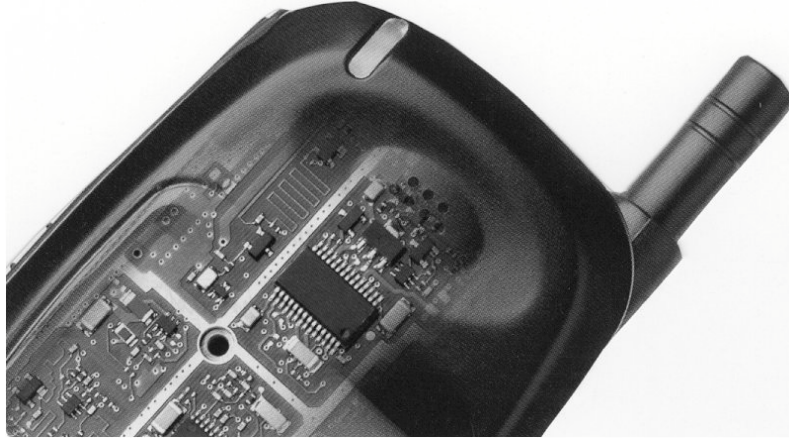

Typical Application- Cell Phone.

125

## **RF / Microwave Design - PC Board Materials**

- ◆ Don't Use FR4 in High Power Circuits or Broad Band Applications (Loss & Er).
- ◆ Dielectric Loss (Loss Tangent) causes as much as 1/2 Signal Loss in 3" Trace Run over Thick Dielectrics in FR4 at 12 GHz.
- ◆ Resistive Loss, Especially Skin Effect, Can be High at Frequencies Above 500 MHz. In Very Sensitive Circuits, even Small Losses Can Create Big Problems (Wadell- pg 25).

126



## **RF / Microwave Design - Board Fab and Assembly**

- ◆ Teflon Based Materials used in Many RF/ Microwave Circuits Require Fab Houses which Specialize in Such Materials.
- ◆ Items Like Tetra-Etch are Essential in the Fabrication of Plated Holes.
- ◆ Items such as Large Ground Planes, Flooded Ground Pins of Parts and Multiple Vias On or Near Component Pads force Very Special Attention to Solder Profiles During Assembly.<sup>127</sup>



## **RF / Microwave Design - Bibliography**

- ◆ Transmission Line Design Handbook. Brian C. Wadell, 1991. (ISBN #0-89006-436-9)
- ◆ RF & Microwave Design Techniques for PCBs. Proceedings, PCB Design Conference West, 2000. Lawrence M. Burns.
- ◆ Partitioning for RF Design. *Printed Circuit Design Magazine*, April, 2000. Andy Kowalewski - Phillips Corporation.
- ◆ Microstrip Lines and Slotlines. Gupta, Garg, Bahl and Bhartia, 1996. (ISBN # 0-89006-766-X)